

WYMIARY: BR.500_S_B_12

TYP	D	B1	BAN	B max	Waga [kg]
BR.500_S_B_12	2045	500	3000	3180	287

WYMIARY: BR.500_S_E_10

TYP	D	B1	BAN	B-Ex	Waga [kg]
BR.500_S_E_10	2045	500	2500	2500	225

BR.500_S_B_12

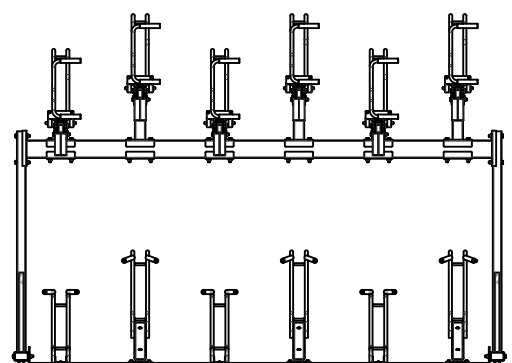

BR.500_S_E_10

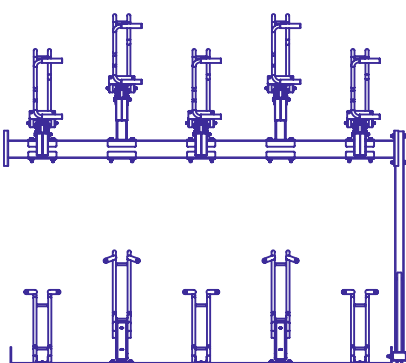

BR.500_S_B_12 + BR.500_S_E_10 = BR.500_S_22

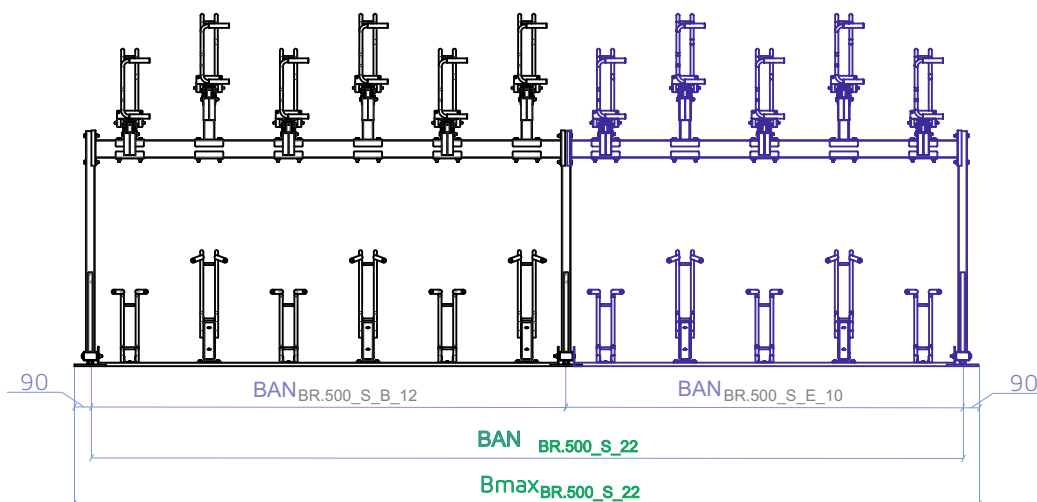

$$BAN_{BR.500_S_B_12} = 3000 \text{ mm}$$

$$BAN_{BR.500_S_E_10} = 2500 \text{ mm}$$

$$BAN_{BR.500_S_22} = BAN_{BR.500_S_B_12} + BAN_{BR.500_S_E_10} = 3000 + 2500 = 5500 \text{ mm}$$

$$Bmax_{BR.500_S_22} = BAN_{BR.500_S_B_12} + BAN_{BR.500_S_E_10} + 90 + 90 = 3000 + 2500 + 90 + 90 = 5680 \text{ mm}$$

$$Waga_{BR.500_S_22} = Waga_{BR.500_S_B_12} + Waga_{BR.500_S_E_10} = 287 + 225 = 512 \text{ kg}$$

WYMIARY: BR.500_S_22

TYP	D	B1	BAN	B max	Waga [kg]
BR.500_S_22	2045	500	5500	5680	512

WYMIARY: BR.500_S_B_12

TYP	D	B1	BAN	B max	Waga [kg]
BR.500_S_B_12	2045	500	3000	3180	287

WYMIARY: BR.500_S_E_12

TYP	D	B1	BAN	B-Ex	Waga [kg]
BR.500_S_E_12	2045	500	3000	3000	265

WYMIARY: BR.500_S_E_10

TYP	D	B1	BAN	B-Ex	Waga [kg]
BR.500_S_E_10	2045	500	2500	2500	225

BR.500_S_B_12

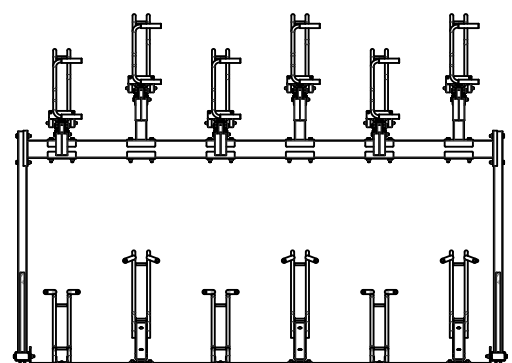

BR.500_S_E_12

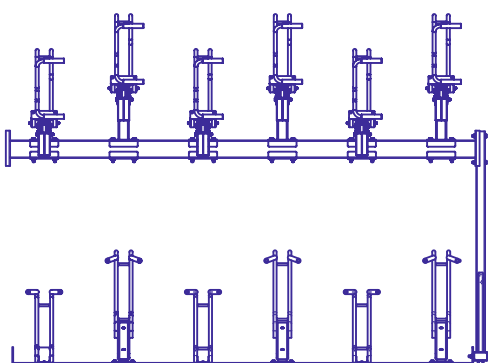

BR.500_S_E_10

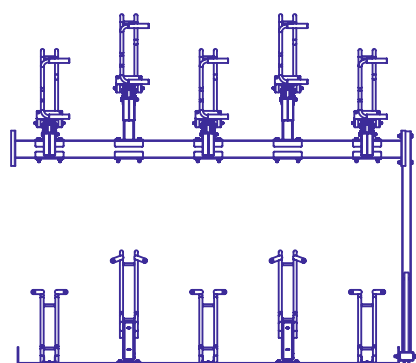

$$\text{BR.500_S_B_12} + \text{BR.500_S_E_12} + \text{BR.500_S_E_10} = \text{BR.500_S_34}$$

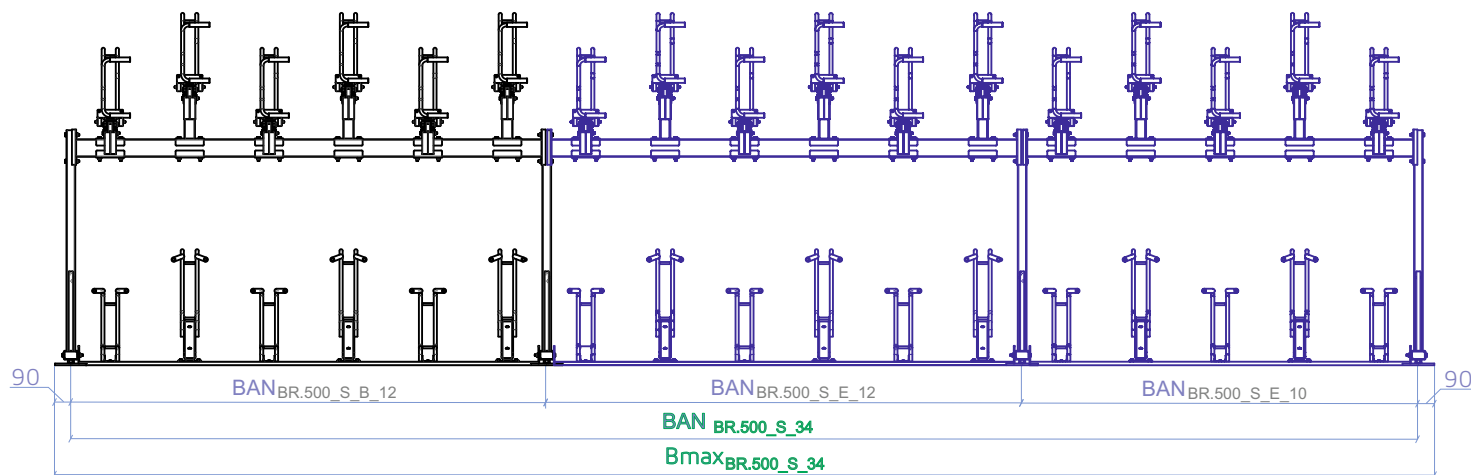

$$\text{BAN}_{\text{BR.500_S_B_12}} = 3000 \text{ mm}$$

$$\text{BAN}_{\text{BR.500_S_E_12}} = 3000 \text{ mm}$$

$$\text{BAN}_{\text{BR.500_S_E_10}} = 2500 \text{ mm}$$

$$\text{BAN}_{\text{BR.500_S_34}} = \text{BAN}_{\text{BR.500_S_B_12}} + \text{BAN}_{\text{BR.500_S_E_12}} + \text{BAN}_{\text{BR.500_S_E_10}} = 3000 + 3000 + 2500 = 8500 \text{ mm}$$

$$\text{Bmax}_{\text{BR.500_S_34}} = \text{BAN}_{\text{BR.500_S_B_12}} + \text{BAN}_{\text{BR.500_S_E_12}} + \text{BAN}_{\text{BR.500_S_E_10}} + 90 + 90 = 3000 + 3000 + 2500 + 90 + 90 = 8680 \text{ mm}$$

$$\text{Waga}_{\text{BR.500_S_34}} = \text{Waga}_{\text{BR.500_S_B_12}} + \text{Waga}_{\text{BR.500_S_E_12}} + \text{Waga}_{\text{BR.500_S_E_10}} = 287 + 265 + 225 = 777 \text{ kg}$$

WYMIARY: BR.500_S_34

TYP	D	B1	BAN	B max	Waga [kg]
BR.500_S_34	2045	500	8500	8680	777

